

Dolphin pro

12V 90A Charger



Plug and Play Battery Charger

Protection:

- Output overload
- Excessive internal temperature
- Charging voltage too high
- Reverse battery polarity (fuse)

Input Voltage	115V / 230V (+/- 15%) Auto Switch
Frequency	50Hz / 60Hz (+/-10%)
Cos	> 0.9 typ
Efficiency	0.83
Max. Current 115V/230V	16A / 7A
Input Fuse (6.3x32mm)	T20A
Outputs	3 isolated outputs
Charging curves	9 programs, position selected by dip switch
Charging curve	IUuo 3 modes
Voltage share	+/-2%
Ripple	< 1% (BW < 20MHz)
Output Fuse (auto. mini)	4 x F30A
Display	LED display or optional touch multi-colour Touchview
Operating Temperature	-10°C to +55°C
Operating Humidity	10% to 95% (without condensation)
IP	IP22
Ventilation	Forced fan adjustable speed cooling
Safety	EN 60335-1
EMC	EN 55016, IEC 61000
Housing	Powder coated aluminium
Mounting	Wall mounted 4 x M4 screws
Dimensions	346 x 358 x 128 mm
Weight	6 Kg
AC Connection	3-point cage terminal 10mm ² max
DC Terminal	4 M8 terminals
Output alarm contact	1A 30V NO
Battery temp. sensor	2-point 1,5 mm ² cage terminal
External touch screen control panel (Touchview)	RJ45
CAN Bus connection	2 Micro-Fit & RJ11

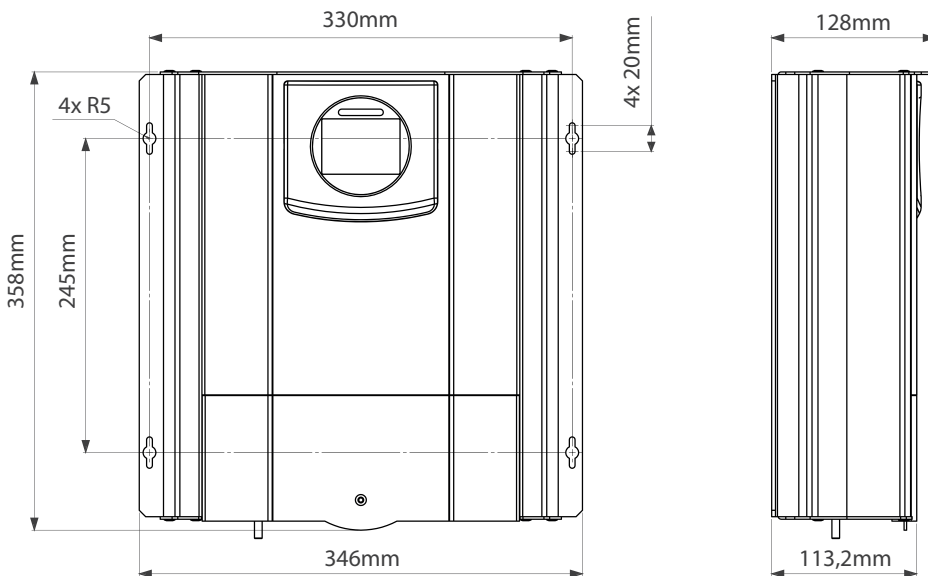

Part No. 399150 **Model** 12V 90A

Proudly distributed by:



16 Parkinson Lane
O'Connor WA 6163
Australia

Phone +61 8 9331 3100
Fax +61 8 9331 5150
Email mail@amelec.com.au
Web www.amelec.com.au