

Battery Master Switch

Single Pole 75A Continuous

CODE NUMBER: 500001



GENERAL

Key/handle removable in OFF position only.

ELECTRICAL

Rated Voltage: 48VDC maximum
 Rated Current: 75/350 Amps sustained/5 secs
 Configuration: Normally Open (N/O)

PHYSICAL

Termination: M10 copper studs
 Stud Torque: 15 ± 1.0 Nm
 Contacts: Copper
 Hardware: Brass nuts and washers
 Construction: Thermoplastic body and handle
 Environmental: IP67
 Operating Temp: -40°C to $+85^{\circ}\text{C}$
 Dimensions: 57mmL x 57mmW x 103mmH
 Weight (nominal): 135 Grams

A range of economical thermoplastic switches for auxiliary circuits in many boats and yachts. Available as a standard switch, with weather seal boot and cap or as a key lock version.

SPARE PARTS

Handle: Order no. 500032

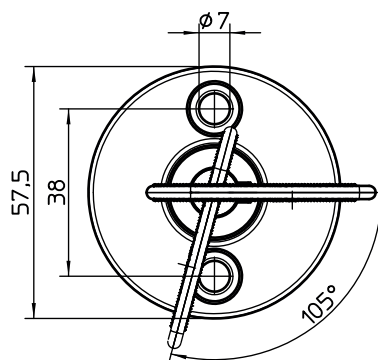
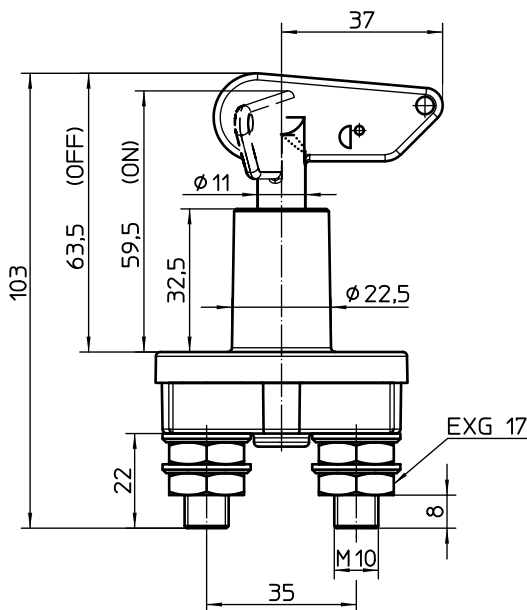

Connection

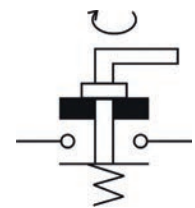

Fixing

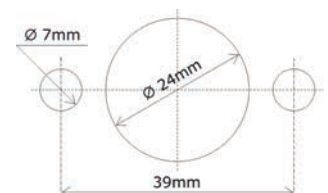

Proudly distributed by:



16 Parkinson Lane
 O'Connor WA 6163
 Australia

Phone +61 8 9331 3100
Fax +61 8 9331 5150
Email mail@amelec.com.au
Web www.amelec.com.au