



GPS-BB-60



GPS-BS-60

The speedometer precisely shows the actual speed and actual compass heading without any signal inputs from the yacht. The signal comes from the 32-channel GPS signal receiver that comes along with the unit. The GPS speedometer has the advantages of high precision, quick location confirmation, and short start up time. Most importantly, the GPS speedometer is easy to setup and can be used in all vehicles, boats, and off-road vehicles (12V/24V).

Model	Bezel	Range
GPS-BB-60	Plastic	0 - 60 knots
GPS-BS-60	Stainless	0 - 60 knots

Code numbers
Operating voltage

GPS-BB-60, GPS-BS-60.

12 VDC - default;

- Compatible also with 24V for stepping motor and LCD type gauges;
- Require an extra resistor to work with 24V for cross coil type gauge;

Material
Protection

316 stainless steel bezel with curved glass;
IP67 protection rating for the whole gauge;
can work up to 1m underwater;

Features

Excellent anti-fogging performance;
Easy installation with multi-plug socket connection design;

Backlight

red or yellow.

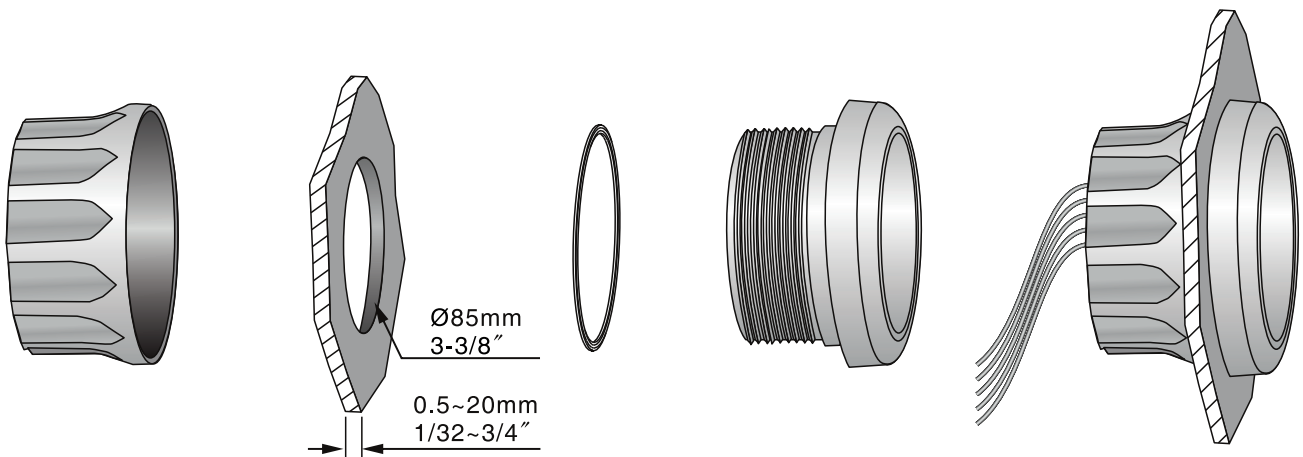

Proudly distributed by:



16 Parkinson Lane
O'Connor WA 6163
Australia

Phone +61 8 9331 3100
Fax +61 8 9331 5150
Email mail@amelec.com.au
Web www.amelec.com.au